

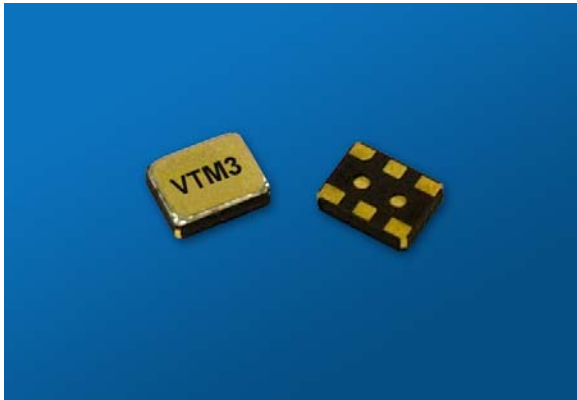

## VTM3 series Voltage Controlled Temperature Compensated Crystal Oscillator



The VTM3, VCTXCO

### Features

- Small 3.2x2.5 package size
- Clipped Sine Wave Output
- Output Frequencies to 45 MHz
- Fundamental Crystal Design
- Optional VCXO Function available
- Gold over nickel contact pads
- Hermetically Sealed Ceramic SMD package
- Product is compliant to RoHS directive  and fully compatible with lead free assembly

### Applications

- GPS
- WiMAX, Wi-Fi, Wi-LAN
- Seismic Exploration
- Point to point radios
- Broadband Access
- Test Equipment
- PDA's

### Description

Vectron's VTM3 Temperature Compensated Crystal Oscillator (TCXO) is a quartz stabilized, clipped sine wave output, temperature compensated oscillator, operating off either 2.8, 3.0, or 3.3 volt supply.

## VTM3 Data Sheet

### Performance Characteristics

Table 1. Electrical Performance					
Parameter	Symbol	Min	Typical	Maximum	Units
Frequency	$f_o$	8.000		45.000	MHz
Typical Supply Voltage <sup>1</sup> <i>Ordering option, see last page</i>		2.8, 3.0, or 3.3			Vdc
Supply Current 8.000 MHz to < 20.000 MHz 20.000 MHz to < 32.00 MHz 32.000 MHz to 45.00 MHz	$I_{DD}$			1.5 2.0 2.5	mA
Output Level <sup>2</sup>	Vp/p	0.8			V
Output Load			10K    10pf		
Control Voltage Impedance	$Z_{Vc}$	500			Kohm
Control Voltage to reach pull <i>All options (3.3,3.0 and 2.8V)</i>		0.5		2.5	V
Pull Range <i>Ordering option, see last page</i>	TPR	±5, ±8, ±10, ±15			ppm
Temperature Stability <i>Ordering option, see last page.</i>		±0.5 to ±5.0			ppm
Initial Accuracy, "No Adjust" option			±0.5	±1.0	ppm
Power Supply Stability				±0.2	ppm
Load Stability				±0.2	ppm
Aging				±1.0	ppm/year
Operating temperature <i>Ordering option, see last page</i>		0/55, -10/60, -20/70, -30/80, -40/85			°C
Phase Noise, 12.000MHz 10 Hz offset 100 Hz offset 1 kHz offset 10 kHz offset 100 kHz offset 1 MHz offset 5 MHz offset			-89 -117 -135 -148 -153 -154 -155		dBc/Hz
Start-up time				2	ms

1. A 0.01uF and a 0.1uF capacitor should be located as close to the supply as possible (to ground) is recommended.

2. Output is DC coupled.

## VTM3 Data Sheet

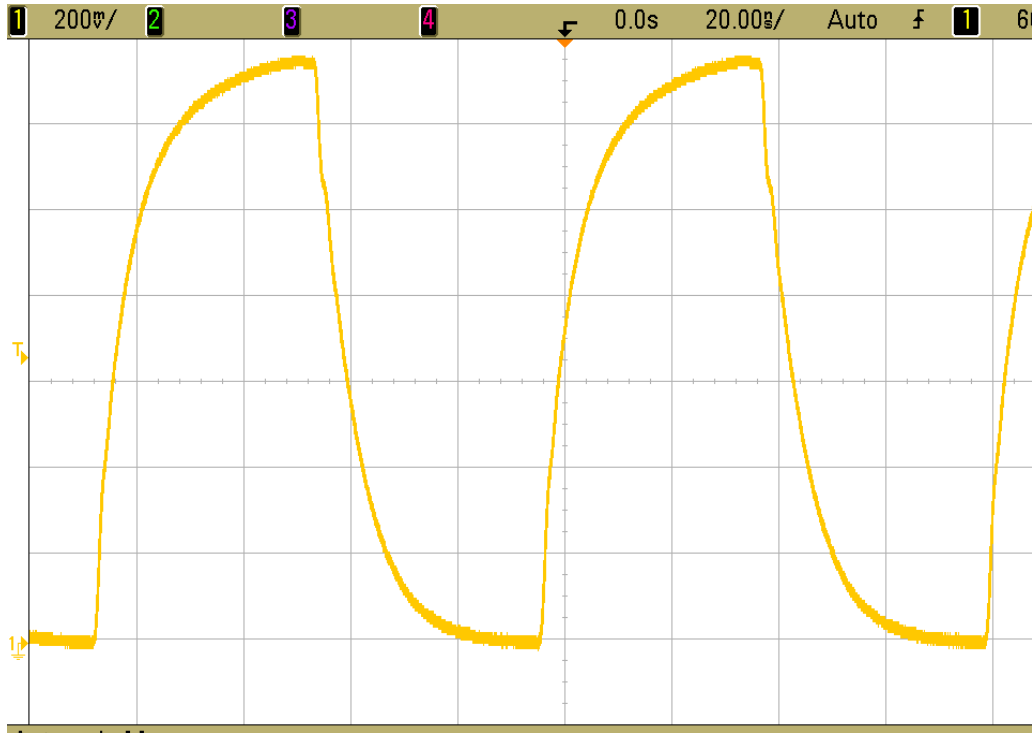

Figure 2. Clipped Sine Wave Output

### VCXO Functional Description

**VCXO Feature:** The VTM3 can be ordered with a VCXO function for applications where it will be used in a PLL, or the output frequency needs fine tune adjustments. This is a high impedance input, 0.5 Mohm, and can be driven with an op-amp or terminated with adjustable resistors etc. **Pin 1 should not be left floating** on the VCXO optional devices.

**“No Adjust” Feature:** In applications where the VTM3 will not be used in a PLL, or the output frequency does not fine tune adjustments, the best device to use would be a VTM3-x0xx. By using the “no adjust” option, the circuit is simplified as  $V_c$  does not need to adjusted or set to a predetermined voltage and **pin 1 should be grounded** (pin 1 can be left open but should not be set to a voltage such as the supply).

Outline Diagrams, Pad Layout and Pin Out

TOP VIEW

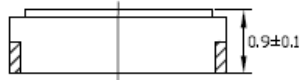
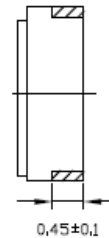
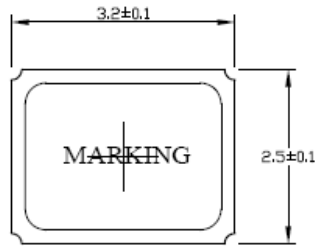

- Pin 1, Ground or VC
- Pin 2, NC
- Pin 3, Ground
- Pin 4, Output
- Pin 5, NC
- Pin 6, VCC
- Pin 7, NC
- Pin 8, NC

BOTTOM VIEW

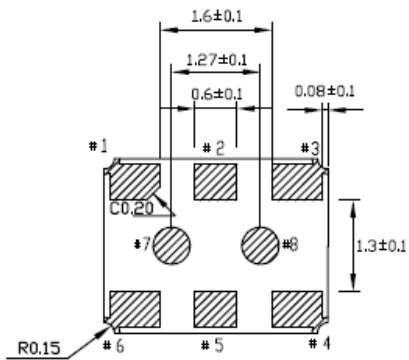

LAND PATTERN (REFERENCE)

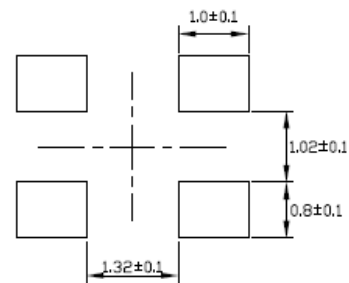

Contact Pads are gold over nickel  
 Devices will be marked with the frequency  
 Pin 2,5,6,7,8 are used to program and adjust the TCXO during manufacturing and should be left open; do not terminate these to the supply voltage and are a "make no connection" pad.

Figure 3, Package drawing

# VTM3 Data Sheet

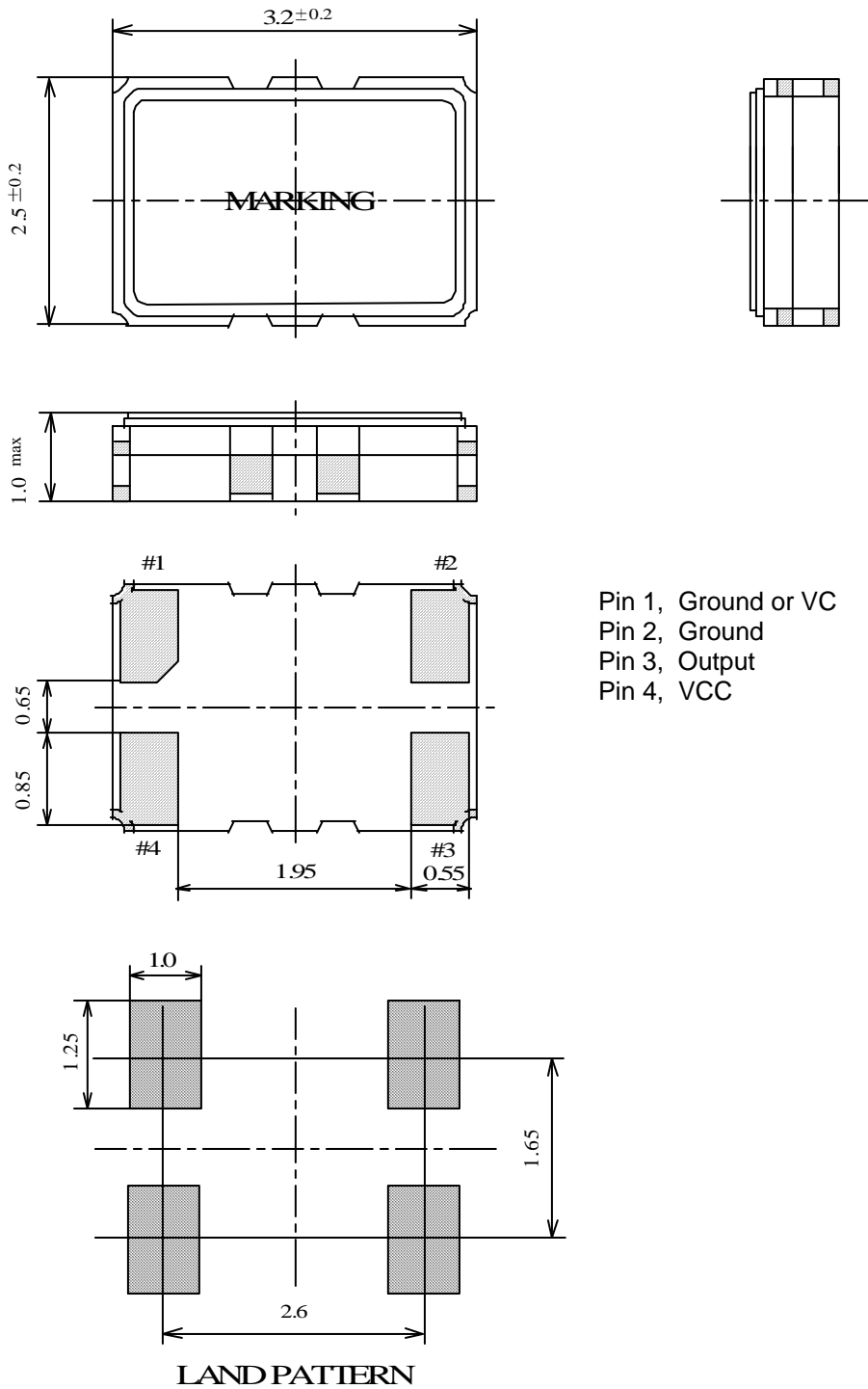

Contact Pads are gold over nickel  
 Devices will be marked with the frequency

**Figure 4, Package drawing for  $\pm 0.5\text{ppm}$  over  $-30/80^\circ\text{C}$  and  $\leq \pm 2\text{ppm}$  over  $-40/85^\circ\text{C}$**

# VTM3 Data Sheet

## Tape and Reel

**Table 3. Tape and Reel Dimensions (mm)**

Tape Dimensions					Reel Dimensions								# Per Reel
Product	A	B	C	D	E	F	G	H	I	J	K	L	Reel
VTM3	8	1.75	1.55	4	4	2.5	22	13	60	1.75	11.5	178	1000

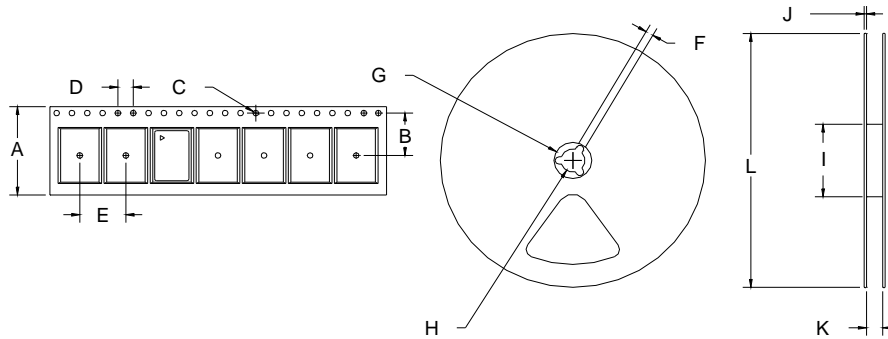

## Absolute Maximum Ratings

Stresses in excess of the absolute maximum ratings can permanently damage the device. Functional operation is not implied at these or any other conditions in excess of conditions represented in the operational sections of this data sheet. Exposure to absolute maximum ratings for extended periods may adversely affect device reliability.

**Table 4. Absolute Maximum Ratings**

Parameter	Symbol	Ratings	Unit
Storage Temperature	T <sub>storage</sub>	-40/85	°C

## Reliability

The VTM3 qualification tests have included:

**Table 5. Environmental Compliance**

Parameter	Conditions
Mechanical Shock	MIL-STD-883 Method 2002
Mechanical Vibration	MIL-STD-883 Method 2007
Temperature Cycle	MIL-STD-883 Method 1010
Solderability	MIL-STD-883 Method 2003
Gross and Fine Leak	MIL-STD-883 Method 1014
Resistance to Solvents	MIL-STD-883 Method 2015
Moisture Sensitivity Level	1
Contact Pads	Gold over Nickel

## VTM3 Data Sheet

### Handling Precautions

Although ESD protection circuitry has been designed into the the VTM3, proper precautions should be taken when handling and mounting. VI employs a Human Body Model and a Charged-Device Model (CDM) for ESD susceptibility testing and design protection evaluation. ESD thresholds are dependent on the circuit parameters used to define the model. Although no industry wide standard has been adopted for the CDM, a standard HBM of resistance = 1.5kohms and capacitance = 100pF is widely used and therefore can be used for comparison purposes.

Table 6. ESD Ratings		
Model	Minimum	Conditions
Human Body Model	1000	MIL-STD-883 Method 3115
Charged Device Model	1000	JESD 22-C101

### Suggested IR profile

Devices are built using lead free epoxy and can also be subjected to standard lead free IR reflow conditions, Table 7 shows max temperatures and lower temperatures can also be used e.g. peak temperature of 220C.

Table 7. Reflow Profile (IPC/JEDEC J-STD-020)		
Parameter	Symbol	Value
PreHeat Time	$t_s$	60 sec Min, 180 sec Max
Ramp Up	$R_{UP}$	3 °C/sec Max
Time Above 217 °C	$t_L$	60 sec Min, 150 sec Max
Time To Peak Temperature	$t_{AMB-P}$	480 sec Max
Time At 260 °C (max)	$t_P$	10 sec Max
Time At 240 °C (max)	$t_{p2}$	60 sec Max
Ramp Down	$R_{DN}$	6 °C/sec Max

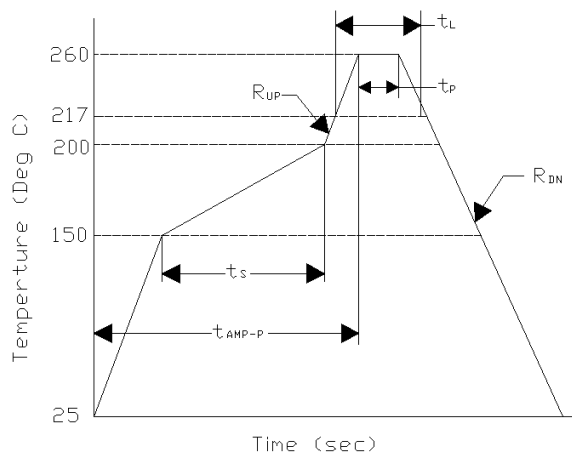

**Ordering Information**

**Table 8. Standard Frequency List**

10.000	12.000	12.800	13.000	13.568	14.000	14.7456	16.000
16.367	16.367667	16.367673	16.368	16.369	16.376	16.800	19.200
19.440	19.6608	19.680	20.000	23.104	24.5535	25.000	26.000
27.456	32.000	39.000					

**VTM3 - B 0 2 C - 12M800**

**Product Family**  
TCXO, 3.2 x 2.5

**Voltage Options**  
 B: +3.3 Vdc ±5%, Clipped Sine Output  
 C: +3.0 Vdc ±5%, Clipped Sine Output  
 D: +2.8 Vdc ±5%, Clipped Sine Output

**Pulling Range**  
 0: Fixed TCXO, no adjust  
 1: ±5ppm  
 2: ±8ppm  
 3: ±10ppm  
 4: ±15ppm

**Output Frequency**  
In MHz

**Temperature Options**  
 A: 0 to 55°C  
 B: -10 to 60°C  
 C: -20 to 70°C  
 D: -30 to 80°C  
 E: -40 to 85°C

**Stability Options**  
 A: ±0.5ppm  
 1: ±1.0ppm  
 B: ±1.5ppm  
 2: ±2.0ppm  
 C: ±2.5ppm  
 3: ±3.0ppm  
 D: ±3.5ppm  
 4: ±4.0ppm  
 5: ±5.0ppm

**Note: Not all combinations are available**



[www.vectron.com](http://www.vectron.com)

**USA:** Vectron International • 267 Lowell Road, Hudson, NH 03051  
 • Tel: 1-88-VECTRON-1 • Fax: 1-888-FAX-VECTRON  
**EUROPE:** Landstrasse, D-74924, Neckarbischofsheim, Germany •  
 Tel: 49 (0) 7268 8010 • Fax: 49 (0) 7268 801281  
**ASIA:** Vectron Asia Pacific Sales 1F~2F, No.8 Workshop No.308 Fenju Rd.,  
 WaiGaoQiao Free Trade Zone, Pudong New Area Shanghai, China 200131  
 •Tel: 8621 50480777 • Fax: 8621 50481881

Revision	Date	Date	Description
1.0	02/15/08		Initial Release